

EPSON

Color Ink Jet Printer

EPSON STYLUS™ PHOTO 895

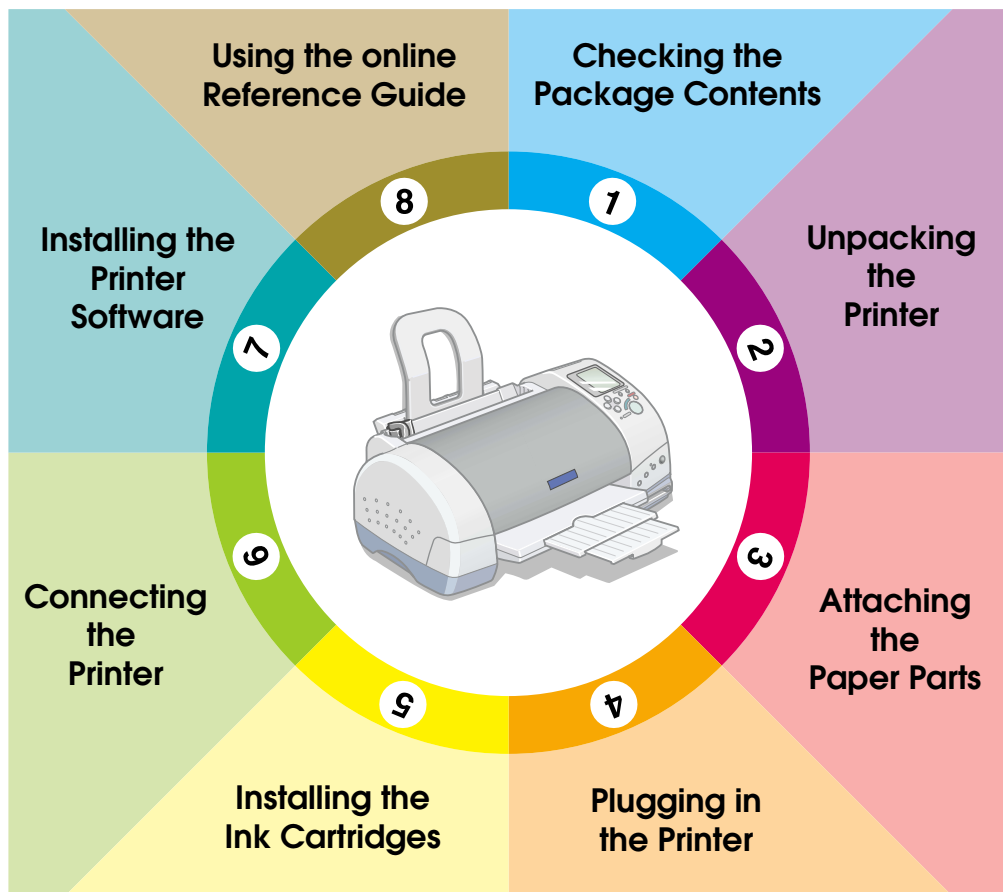

Setup Guide

This Setup Guide provides two kinds of information on setting up your printer and installing the printer software, both for direct printing and printing with a computer. Follow the instructions appropriate for you.

1

Checking the Package Contents



paper support

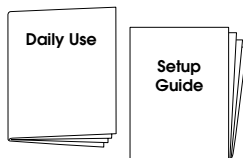

paper manuals



black



color

ink cartridges

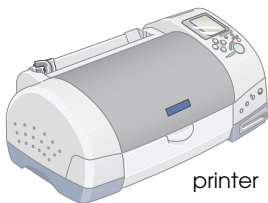

printer



printer software & Reference Guide CD-ROM



power cord*

* The power cord may come attached to the printer in certain locations.

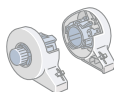

roll paper holder

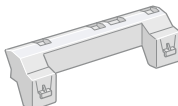

roll paper holder adapter

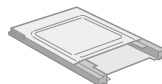

PC card adapter for CompactFlash

The package contents may vary in certain locations.

2

Unpacking the Printer

Remove all tape and protective materials from the printer.

①

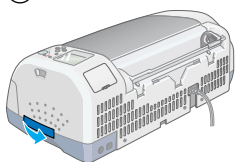

②

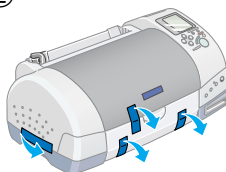

③

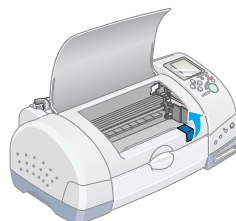

3

Attaching the Printer Parts

Insert the paper support into the slots at the rear of the printer.

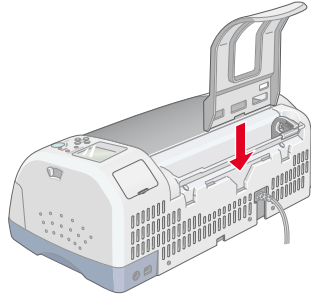

To attach the roll paper holder, follow the instructions below.

1. With the arrows on the roll paper holder adapter pointing towards the front of the printer, insert the adapter as far as it will go into the slot at the rear of the printer.
2. Insert the roll paper holder into the slots at the back of the roll paper holder adapter.

Note:

You can temporarily mount the roll paper holder on the printer by inserting it into slots at the rear of the paper support adapter. You do not need to load roll paper at this time.

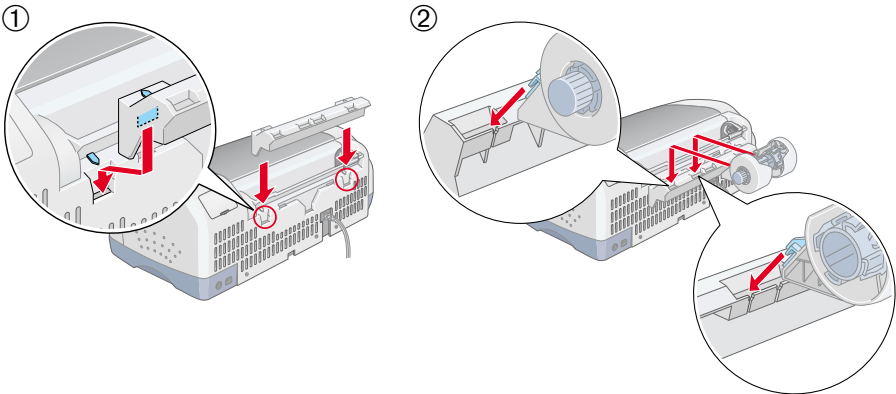

4

Plugging in the Printer

Follow the steps below to plug in your printer.

1. Make sure that the printer is turned off. It is off when the  power button protrudes slightly from the surface of the control panel.
2. Check the label on the back of the printer to make sure the voltage required by the printer matches that of the electrical outlet you will be plugging it into. Also, make sure that you have the correct power cable for your power source.



Caution:

It is not possible to change the printer's voltage. If the rated voltage and your outlet voltage do not match, contact your dealer for assistance. Do not plug in the power cord.

3. If the power cord is not attached to the printer, connect it to the AC inlet at the back of the printer.
4. Plug the power cord into a properly grounded electrical outlet.

5

Installing Ink Cartridges

This printer uses ink cartridges equipped with IC chips. The IC chip accurately monitors the amount of ink used by each cartridge, so even if a cartridge is removed and then inserted again, all of its ink can be used. However, some ink from both color and black ink cartridges is consumed each time a cartridge is inserted because the printer automatically checks reliability.

Be sure to use the ink cartridges packed with your printer the first time that you install ink cartridges.

Installing the Ink Cartridges

Before installing the ink cartridges, note the following:



Warning:

The ink cartridges are self-contained units. Under ordinary use, ink will not leak from a cartridge. If ink does get on your hands, however, wash them thoroughly with soap and water. If ink gets into your eyes, flush them immediately with water.

Note:

Do not open the ink cartridge packages until just before you install them, or the ink may dry up.

Follow the steps below to install the ink cartridges.

1. Open the output tray and the printer cover, then turn on the printer by pressing the  power button.

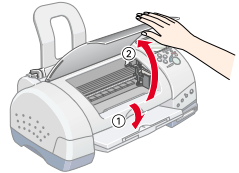

2. Lift up the ink cartridge clamps, as shown here.

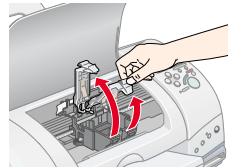

Caution:

Do not move the print head by hand. Doing so may damage the printer.

3. Remove only the yellow tape from the ink cartridges.

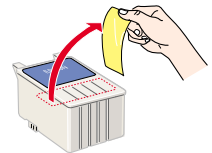
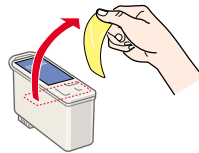

Caution:

- You must remove the yellow tape seals from the cartridges before installing them, or the cartridges will become unusable and you will be unable to print.*
- If you have installed an ink cartridge without removing the yellow tape seal, you must remove that cartridge and install a new one. Prepare the new cartridge by removing the yellow tape seal before installing it in the printer.*
- Do not remove the blue portion of the tape seal from the cartridges, or the cartridges may become unusable.*
- Do not remove the tape seals from the bottom of the cartridges, or ink will leak out.*
- Do not touch the green IC chip on the side of the cartridge. Doing so may prevent normal operation and printing.*
- Do not remove the green IC chip from the side of the cartridge. If you install an ink cartridge without a chip, the printer may be damaged.*

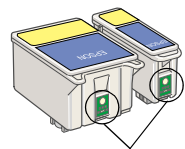

Do not touch this part.

4. Align the tabs on each ink cartridge so that they rest on top of the tabs protruding from the base of the ink cartridge clamps. Do not apply excessive force to the cartridges. Make sure that the ink cartridge tabs are not under the tabs protruding from the base of the opened ink cartridge clamps.

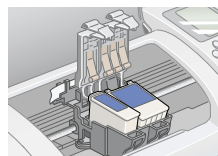
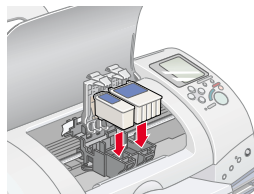

Note:

Install both ink cartridges. The printer will not work with only one cartridge.

5. Lower the ink cartridge clamps until they lock into place.
6. Press the  ink cartridge replacement button. The printer moves the print head and begins charging the ink delivery system. This process takes about two and a half minutes.

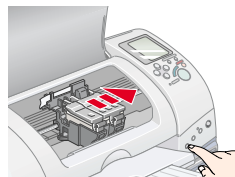

Caution:

Always press the  ink cartridge replacement button to move the print head. Do not move the print head by hand. Doing so may damage the printer.

While the ink is charging, the Processing light flashes and the Select Photo display rotates. During this process, printer will emit a variety of mechanical sounds. These sounds are normal. When the ink delivery system is charged, the print head will return to the home (far right) position and the Processing light will come on.



Caution:

Never turn off the printer while the processing light is flashing and the Select Photo display is rotating.

7. Close the printer cover.

Checking the printer

Before printing your first page, you need to make sure that the printer is working correctly by loading paper, then printing a nozzle check page and, if necessary, cleaning the print head. Refer to the appropriate section below.

Loading paper

Follow the steps below to load plain paper into the printer.

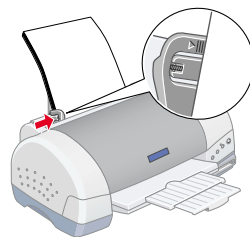

1. Lower the output tray and slide out the extension. Slide the left edge guide so that the distance between the edge guides is slightly wider than your paper.
2. Fan a stack of paper, then tap it on a flat surface to even the edges.
3. Load the stack of paper into the sheet feeder with the printable side up and the right edge of the paper flush against the right edge guide. Slide the left edge guide against the left edge of the paper.



Note:

- ❑ *Always load paper into the sheet feeder short edge first.*
- ❑ *Make sure that the paper stack fits under the arrow mark inside the edge guide.*

Checking the print head nozzles

Make sure that the printer is turned off. Hold down the  maintenance button (① in the illustration) and press the  power button (② in the illustration) to turn on the printer. Release only the power button, and when the printer starts the nozzle check, release the  maintenance button.

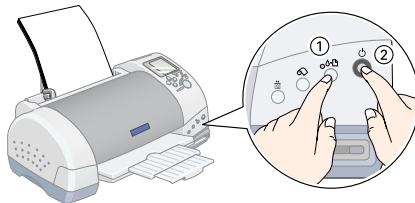

Below are sample printouts.

Good sample

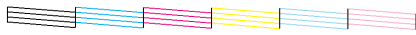

Print head needs to be cleaned

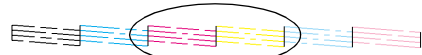

Segments are missing

If the nozzle check page does not print satisfactorily (for example, if any segment of the printed lines is missing), then you should clean the print head as explained below. If the printout is satisfactory, you are ready to print directly from the PC card.

Cleaning the print head

Follow the steps below to clean the print head.

1. Make sure that the Processing light is on and that the Δ error light is off.
2. Hold down the Δ maintenance button for three seconds.

The printer will start cleaning the print head and the Processing light will start flash. Print head cleaning takes about thirty seconds to complete.

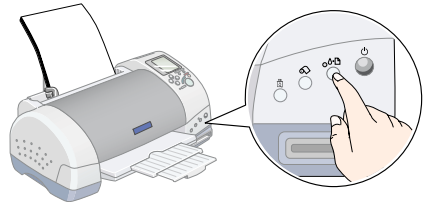

Caution:

Never turn off the printer while the Processing light is flashing. Doing so may damage the printer.

3. When the Processing light stops flashing, print a nozzle check pattern to confirm that the head is clean and to reset the cleaning cycle.

If print quality hasn't improved after repeating the nozzle checking and cleaning procedures four or five times, contact your dealer.

6

Connecting the Printer

Your printer connects to your computer via the USB interface. Depending upon your geographic location, you may need to obtain the appropriate cable. See “Options and Consumable Products” in the *Daily Use* guide for details.

Note:

In order to connect your PC via the USB interface, your computer must be a Windows Me, Windows 98 or Windows 2000 pre-installed model that comes with a USB port, or Windows Me upgraded from a Windows 98 pre-installed model.

To connect the printer to a USB port, you will need a standard, shielded USB cable. Follow these steps:

Note:

- ❑ *For best results, you should connect the printer directly to the computer’s USB port. If you must use multiple USB hubs, we recommend that you connect the printer to the first-tier hub.*
- ❑ *If your computer has more than one USB port, you may plug the cable in wherever is convenient.*

1. Make sure that both the printer and the computer are turned off.
2. Plug the appropriate end of the cable into the USB port on the back of the printer. (The end that fits the printer has a different shape from the end that fits the computer.)
3. Connect the other end of the cable to the computer’s USB port.

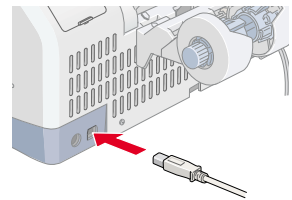

7

Installing the Printer Software

After connecting the printer to your computer, you need to install the software included on the “Printer Software for EPSON Stylus Photo 895” CD-ROM shipped with your printer.

The printer software CD-ROM contains:

- ❑ Printer software (printer driver and utilities)
The printer driver runs, or “drives,” your printer; use it to make settings such as print quality, speed, media type, and paper size.
- ❑ EPSON PhotoQuicker
This utility lets you print digital photos with ease, using a wide variety of layouts.
- ❑ EPSON PhotoStarter
This utility automatically launches EPSON PhotoQuicker and loads photo data when a memory card is inserted into the printer’s PC card slot. You can also setup it to automatically launch an application without EPSON PhotoQuicker and save your photo file to your computer whenever you insert a memory card.
- ❑ EPSON CardMonitor
This utility works with EPSON PhotoStarter. It monitors the PC card slots in your printer and computer.
- ❑ Online guides
The online *Reference Guide* helps you learn more about your printer.

Refer to the appropriate section.

Installing in Windows

Follow the instructions in this section to install the printer software and EPSON PhotoQuicker.

Note:

For Windows 2000 users, if the Digital Signature Not Found screen appears during the installation process, click Yes. If you click No, you will have to return to step1 and install the printer software again.

Installing the printer software

Follow these steps to install the printer software.

1. Turn on your computer and start Windows. If the New Hardware Found dialog box or any other Wizard appears, click Cancel.
2. Insert the printer software CD in the CD-ROM drive. If the Installer dialog box does not appear, double-click EPSETUP.EXE in the CD-ROM.

3. Select Install Printer Driver/Utility, and click .

Note:

It is possible to install the Reference Guide on your hard drive from the Installer dialog box, as shown to the right. To install the guide, click Online Guide and then . Next, click Install Reference Guide and follow the on-screen instructions. When the installation is complete, an ESP 895

Guide icon will appear in the EPSON folder. Double-click the icon to open the guide.



4. Click OK in the dialog box that appears.

If Problem Solver is available in your location, it is automatically installed on your hard drive.

Note:

The Problem Solver provides tips and instructions to help you solve most problems you may encounter when printing. The Problem Solver can be accessed through the EPSON folder, Status Monitor 3, or the printer software. For details, see the “Diagnosing the Problem” section of your online Reference Guide.

5. Follow the on-screen instructions to turn on your printer.

USB device driver installation starts automatically at this point for printers connected via the USB cable. When a message appears asking you to restart your computer, do so.

For Windows 2000 users, go to the next step, “For Windows 2000 Users”.

6. When a message appears informing you that the installation is complete, click OK.

Note:

If an error message appears, it means either the printer software or the EPSON USB printer device driver has not been installed correctly. See “Correcting USB Problems” in the online Reference Guide for details.

For Windows 2000 Users

1. Wait until a message appears informing you that the installation is complete, then Click OK. Do not go to the next step before this procedure.
2. The Found New Hardware Wizard starts.
3. Click Next, then select search for a suitable driver for my device (recommended) and click Next.
4. In the Locate Driver Files screen, select Specify a location, then click Next.
5. When the screen below appears, click Browse, then specify the Win2000 folder in the CD-ROM drive. Then click OK.
6. In the next screen, confirm the driver and the directory, then click Next.
7. When a message appears informing you that the installation is complete, click Finish. If a message appears asking you to restart your computer, do so.



Installing Photo Print Software

Note:

EPSON PhotoQuicker, EPSON PhotoStarter, EPSON CardMonitor are installed.

1. Insert the printer software CD in the CD-ROM drive. The installer dialog box will appear. Choose Install Photo Print Software, click the , then click the Start button. (If the installer dialog box does not appear automatically, double-click EPSETUP.EXE in the CD-ROM.)
2. Follow the on-screen instructions.
3. When a message appears informing you that installation is complete, click the Finish button.

Accessing EPSON Status Monitor 3

After installing the printer software, you need to access EPSON Status Monitor 3 to verify that the printer software has been installed correctly.

Follow the instructions below.

1. From the Start menu, select Settings then click Printers.
2. Right-click the EPSON Stylus Photo 895 icon, then click Properties.
3. Click the Utility tab, then click EPSON Status Monitor 3.
4. If the following window appears, your printer software has been installed correctly.

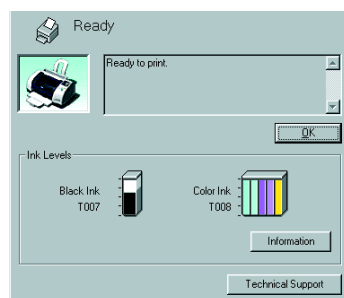

Installing in Macintosh

Follow the instructions in this section to install the printer software, select your printer in the Chooser.



Caution:

Turn off all virus protection programs before you install the printer software.

Installing the printer software and photo print software

Follow these steps to install your printer software and photo print software (EPSON PhotoQuicker, EPSON PhotoStarter, EPSON CardMonitor).

1. Turn on your Macintosh and insert the software CD in the CD-ROM drive.
2. Double-click the Installer icon inside the EPSON folder that automatically opens.

Note:

- ❑ *It is possible to install the Reference Guide on your hard drive from the printer software CD-ROM. To install the guide, double-click the Online Guide icon, then the Online Guide icon. Click Install Reference Guide and follow the on-screen instructions. When the installation is complete, a View Reference Guide icon will appear in the EPSON STYLUS PHOTO 895 folder. Double-click the icon to open the guide.*
 - ❑ *It is possible to access Technical Support from the printer software CD-ROM. Insert the CD in the CD-ROM drive. The EPSON folder will open automatically. Scroll down the screen and open the Disk 1 folder in the Printer Driver folder, then double-click the Technical Support Web Site icon.*
3. Click Start on the Installer dialog box, then follow the on-screen instructions.
 4. When a message appears informing you that installation is complete, click Restart to restart your computer.

Selecting your printer in the Chooser

After you have installed printer software, you need to select your printer.

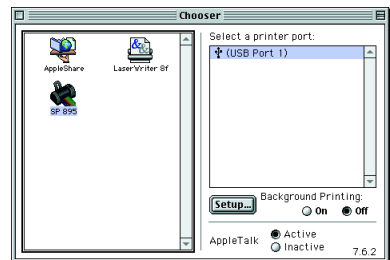

1. Turn on the printer by pressing the ⏻ power button.
2. Choose Chooser from the Apple menu. Then select the icon for your printer and the port that your printer is connected to.
3. Close the Chooser.



Accessing EPSON StatusMonitor

Follow the steps below to access EPSON StatusMonitor.

1. Click Print or Page Setup on the File menu of your application. The Print dialog box opens.

2. Click the  StatusMonitor icon button or click the  Utility icon button and then the EPSON StatusMonitor button in the Utility dialog box. If the following StatusMonitor dialog box appears, your printer software has been installed correctly.

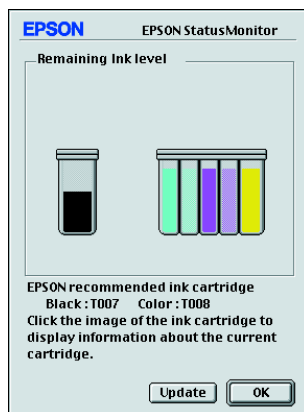

Using EPSON PhotoQuicker

If you have set PhotoStarter to automatically startup PhotoQuicker, PhotoQuicker opens automatically when a PC card is inserted into the appropriate PC card slot.

Setting up EPSON PhotoStarter

1. When a memory card is inserted into printer's card slot first time after installing EPSON PhotoStarter and EPSON CardMonitor, the setup screen will appear on display.
2. Follow the on screen instructions to setup the PhotoStarter to automatically save your photo files to your computer and start a selected application whenever you insert a memory card into PC card slots in your printer and computer.

Launching EPSON PhotoQuicker

You can launch EPSON PhotoQuicker by following methods below.

1. Click the Start button, point to Programs and then EPSON PhotoQuicker, then click EPSON PhotoQuicker3.x (For Windows). Double-click the Macintosh HD icon, then double-click the folder in which EPSON PhotoQuicker has been installed. Double-click the EPSON PhotoQuicker3.x icon (For Macintosh).
2. A dialog box will open where you can specify the location of the data you wish to use.

- To print your photos, click the Help button to access the online guide for instructions.

Note:

You can also view the online User's Guide for PhotoQuicker by clicking the Start menu, then pointing to Programs, then EPSON PhotoQuicker (Windows) or in the EPSON PhotoQuicker folder (Macintosh).



Using the online Reference Guide

Refer to the appropriate section below for the minimum system requirements necessary to use the online *Reference Guide*.

System Requirements

System	Microsoft Windows® Millennium Edition, 98, 2000, or Mac OS 8.5.1
CPU	Pentium 150 MHz processor (for Windows Me) i486/66 MHz (for Windows 98) (Pentium or better recommended) Pentium 133 MHz for Windows 2000
Memory	16 MB RAM for Windows 98 (32 MB RAM or more recommended) 32 MB RAM for Windows Me and 2000 16 MB RAM for Macintosh (32 MB or more recommended)
Hard disk space	5 MB to install the Reference Guide
CD-ROM drive	Double-speed (quad-speed or faster recommended)
Display	640 × 480 pixel or 800 × 600 pixel resolution, with High Color (16 bit) or True Color (32 bit) setting
Browser	Web browser (Microsoft Internet Explorer 4.0 or later recommended)